

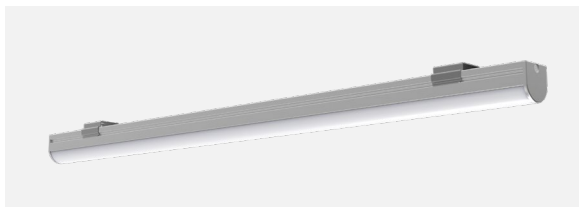

MINI15



MINI15

Range	Linear LED light						
Description	Natural anodized aluminum profile LED strip Clear diffuser, clear diffuser + 60° optics or opal diffuser 2 natural anodized aluminum end caps Metallic fixing clips (2 per meter)						
Dimensions	Width : 17mm (with fixing clips) Height : 18mm (with fixing clips) Length upon request up to 2,500mm						
LED characteristics	2700K – 3000K – 3500K – 4000K CRI 90 R9 > 50						
Separate power supply	24V constant voltage For the US & Canada use a remote UL class 2 power supply						
LED strip	Color temperatures	LED power W/m Lumen/m			CRI	Cut-out size	LED/m
FIRALED 160cc (other upon request)	2700K – 3000K 3500K – 4000K	10.4	15.5	18	90	50mm	160
Connection	5m maximum per driver's output Delivered according to customer's requirement with : <ul style="list-style-type: none"> • A male and a female connector for daisy-chain cabling • 1m cable + female quick connector • Several lengths forming a garland 						
Accessories	Connector board Y extension cables						
Use limitations	The product must be installed into a ventilated area Any use with an ambient temperature higher than the specified ambient temperature (Ta) would lead to a more rapid mortality of the product and the withdrawal of our guarantees The drivers, if not delivered by LOuss, must be approved before use						
Warranty	Life span: L80-B10 = 35,000 hours (80% remaining flux) at 30°C ambient temperature 3-year parts and labor warranty The warranty does not apply to products that have been opened, modified or repaired and does not cover the effects of a wrong connection, careless, abusive handling, overvoltage, lighting injury, as well as the normal wear of the product All products are electrically tested and receive a functional burn-in						

All the connections have to be made before powering up,
otherwise the luminaires could be seriously damaged

LOuss

Creation : 2019.05.16 / Last update : 2025.07.22

2/4

BEST SAS, Capital 200 000€
RCS Dijon B 408 483 485
TVA/VAT n° : FR94 408 483 485
APE 2612Z

Tel. : +33 380 48 65 68
contact@louss.fr
www.louss.fr
Best & LOuss

Siège social / Head Office
PA Les Terres d'Or
Route de Saint Philibert
21220 Gevrey Chambertin - FRANCE

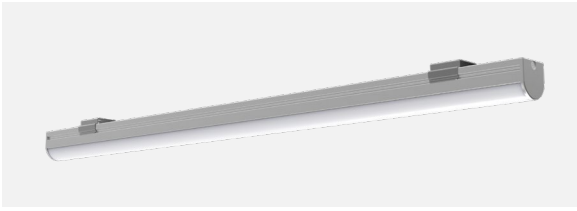

MINI15

Dimensions & Installation guide

Natural anodized aluminum profile

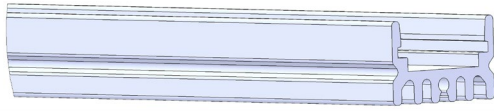

Clear cover with 60° optics

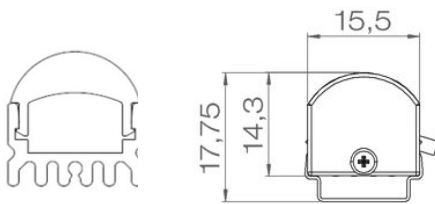

Fixing clips (2 per meter)

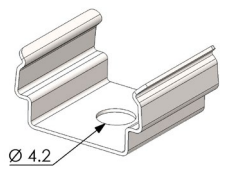

Cut-out size - 50mm



5m max. per driver's output

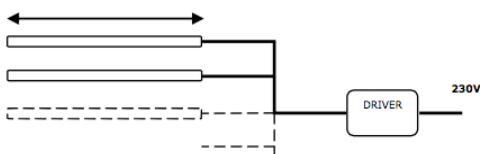

1

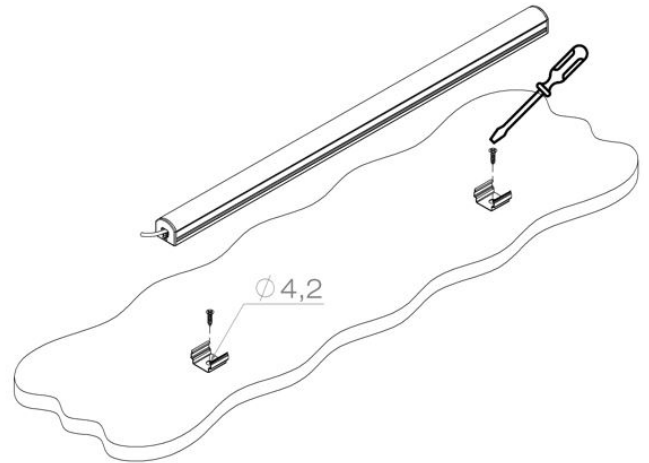

2

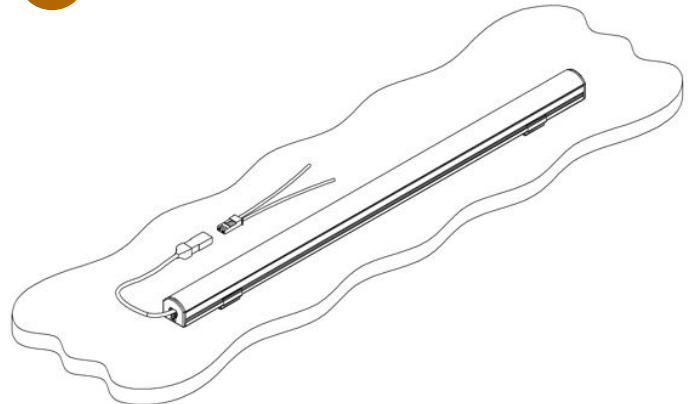

3



All the connections have to be made before powering up, otherwise the luminaires could be seriously damaged

Creation : 2019.05.16 / Last update : 2025.07.22

LOUSS

BEST SAS, Capital 200 000€
RCS Dijon B 408 483 485
TVA/VAT n° : FR94 408 483 485
APE 2612Z

Tel. : +33 380 48 65 68
contact@louss.fr
www.louss.fr
Best & LOUSS

Siège social / Head Office
PA Les Terres d'Or
Route de Saint Philibert
21220 Gevrey Chambertin - FRANCE

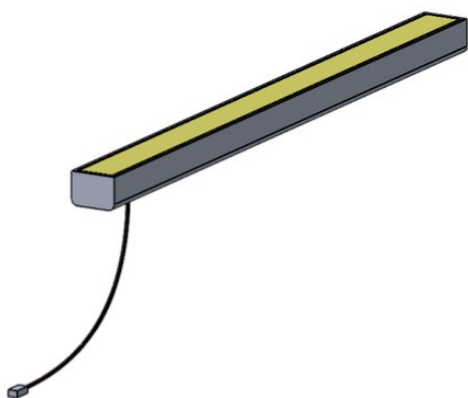

Cable below
 110mm or 250mm cable + male quick connector on 1 end
 or
 1m cable + male quick connector on 1 end

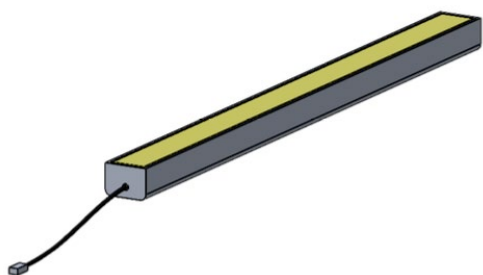

Cable on 1 end
 110mm or 250mm cable + male quick connector on 1 end
 or
 1m cable + male quick connector on 1 end

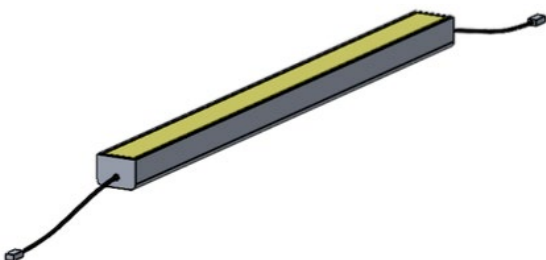

Daisy chain
 110mm or 250mm cable + male quick connector on 1 end
 +
 110mm or 250mm cable + female quick connector on the other end

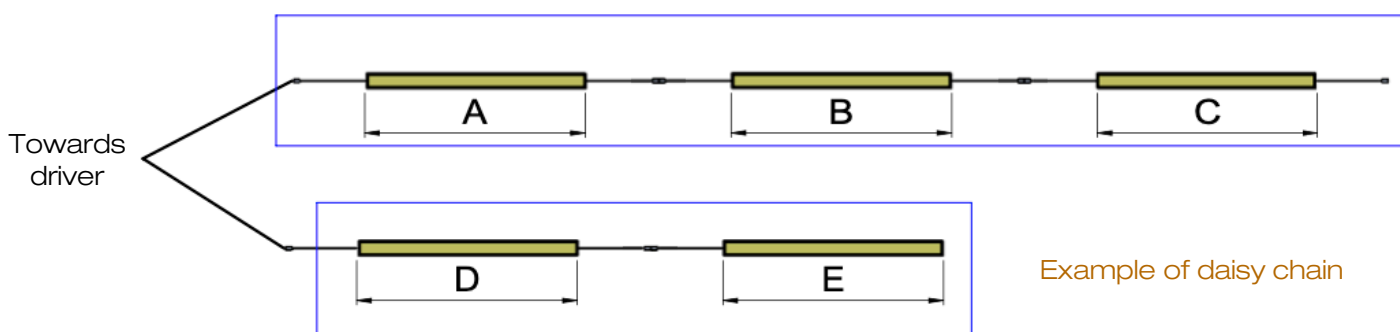

Example of daisy chain

Create as many lines as needed to respect the maximum length per line, according to the selected LED strip and the wattage of the driver

All the connections have to be made before powering up, otherwise the luminaires could be seriously damaged