



**AURORE D42
ON TRACK**



AUORE D42 ON TRACK • 24/48V-S • 24/48V DALI • 230V • 230V DALI

Power supply	24/48V-S • DALI 24/48V	230V • DALI 230V
	Spot adaptator for 24/48V Stucchi Evo System track	<p>230V : Track adapter suitable for Global Trac PRO XTS or similar (ERCO, Trajectoire...)</p> <p>230V DALI : • Track adapter suitable for Global Trac Pulse, STUCCHI, SLV... • Optional : CASAMBI-DALI gateway (see page 5)</p>
Power	4W to 10W according to version	
Electric class	<p>24/48V tracks : class 3</p> <p>230V tracks : class 2</p>	
Use limitations	<p>The product must be installed in a ventilated area</p> <p>Any use with an ambient temperature higher than the specified ambient temperature (Ta) would lead to a more rapid mortality of the product and the withdrawal of our guarantees</p> <p>The drivers, if not delivered by LOuss, must be approved before use</p>	
Warranty	<p>Life span : L80B10 at 50,000 hours (80% remaining flux) at 25°C ambient temperature</p> <p>3-year parts and labour warranty</p> <p>The warranty does not apply to products that have been opened, modified or repaired and does not cover the effects of a wrong connection, careless, abusive handling, overvoltage, lightning injury, as well as the normal wear of the product</p> <p>All products are electrically tested and received a functional burn-in.</p>	

All the connections have to be made before powering up, otherwise the luminaires could be seriously damaged



AURORE D42 ON TRACK 24/48V-S • 24/48V DALI

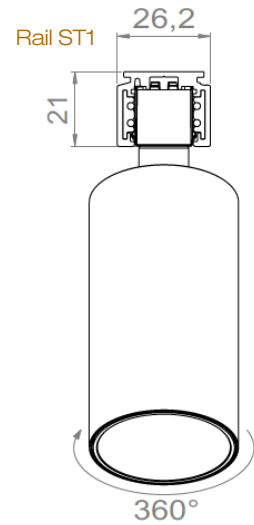
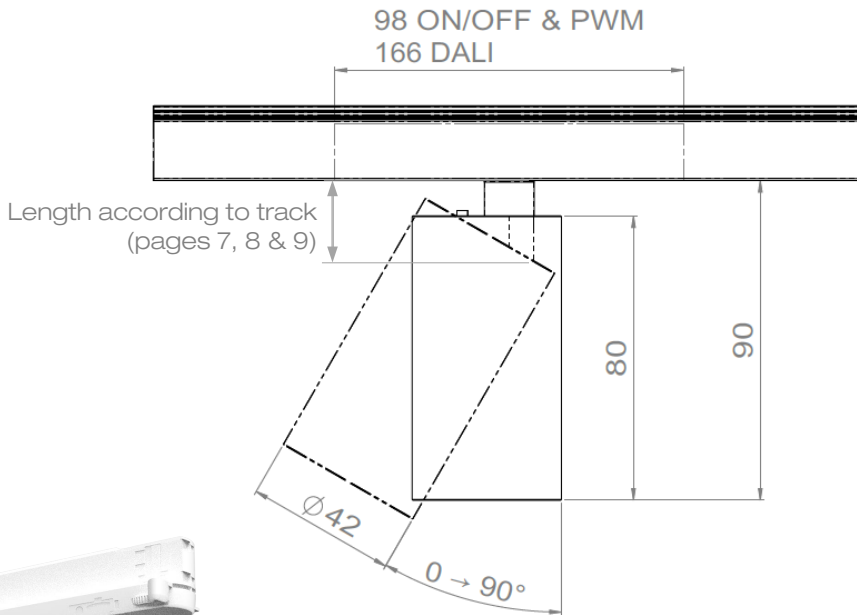

AURORE D42 ON TRACK 230V-S • 230V DALI

Track Global Trac PRO
Warning: Dimensions may vary
by a few mms from one
manufacturer to another

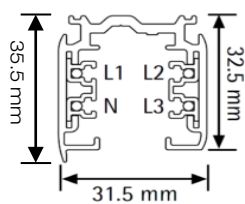

Track DALI Global Trac pulse
Warning: Dimensions may vary
by a few mms from one
manufacturer to another

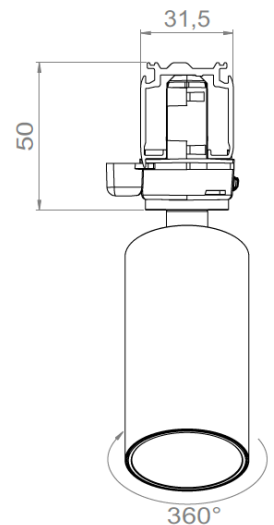
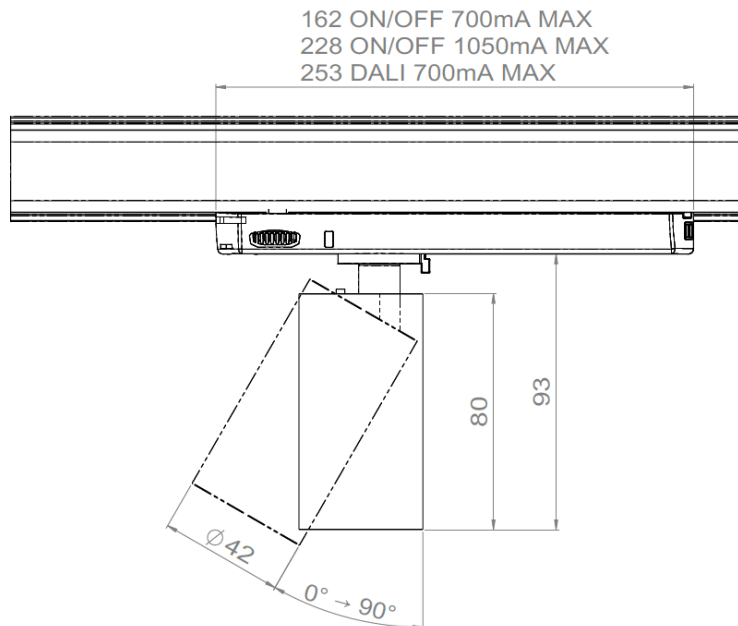
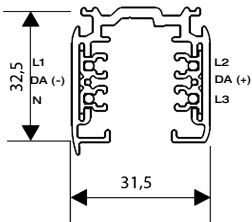

All the connections have to be made before powering up,
otherwise the luminaires could be seriously damaged



AUORE D42 230V TRACK CASAMBI-DALI Wiring system

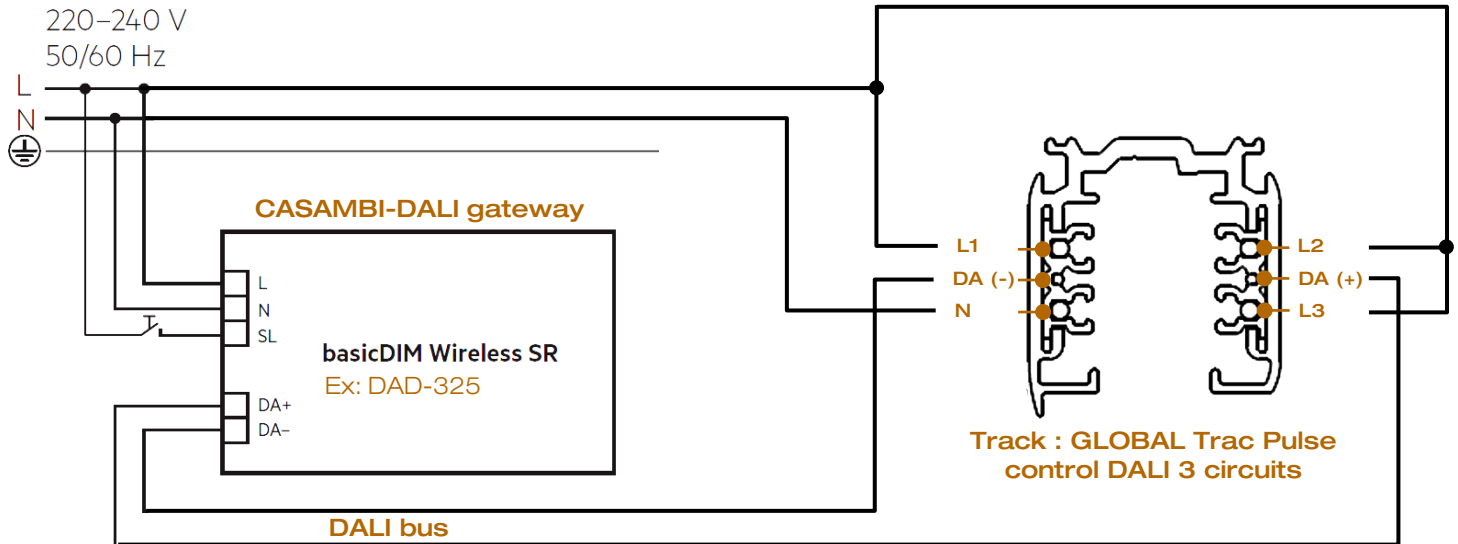

CAUTION : 25 drivers maximum per track

All the connections have to be made before powering up,
otherwise the luminaires could be seriously damaged

LOUSS

Last update : 2025.10.30

5/6

BEST SAS, Capital 200 000€
RCS Dijon B 408 483 485
TVA/VAT n° : FR94 408 483 485
APE 2612Z

Tel. : +33 380 48 65 68
contact@louss.fr
www.louss.fr
Best & LOUSS

Siège social / Head Office
PA Les Terres d'Or
Route de Saint Philibert
21220 Gevrey Chambertin - FRANCE

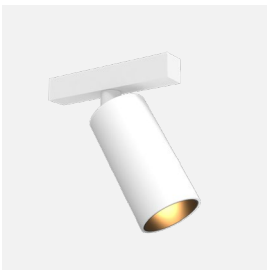

AUORE D42 ON TRACK • 24/48V-S • 24/48V DALI • 230V • 230V DALI

LOuss **Permuto** – Easy swap system



All the connections have to be made before powering up, otherwise the luminaires could be seriously damaged

LOuss

Last update : 2025.10.30

6/6

BEST SAS, Capital 200 000€
RCS Dijon B 408 483 485
TVA/VAT n° : FR94 408 483 485
APE 2612Z

Tel. : +33 380 48 65 68
contact@louss.fr
www.louss.fr
Best & LOuss

Siège social / Head Office
PA Les Terres d'Or
Route de Saint Philibert
21220 Gevrey Chambertin - FRANCE